

KURTARMA VOLANI / HANDWHEEL

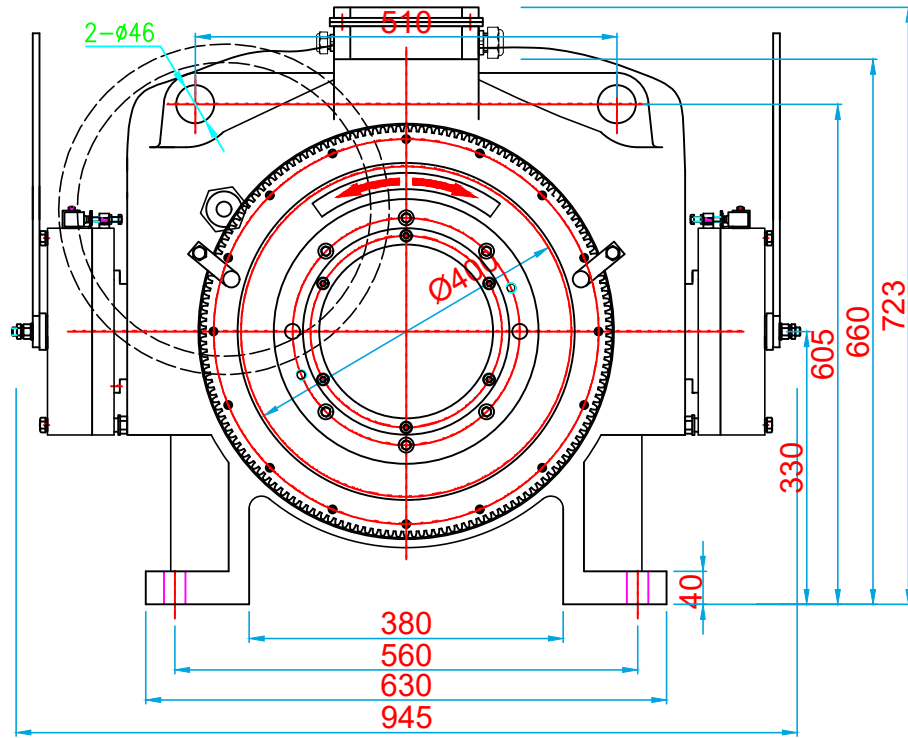

ÖN GÖRÜNÜŞ / FRONT VIEW

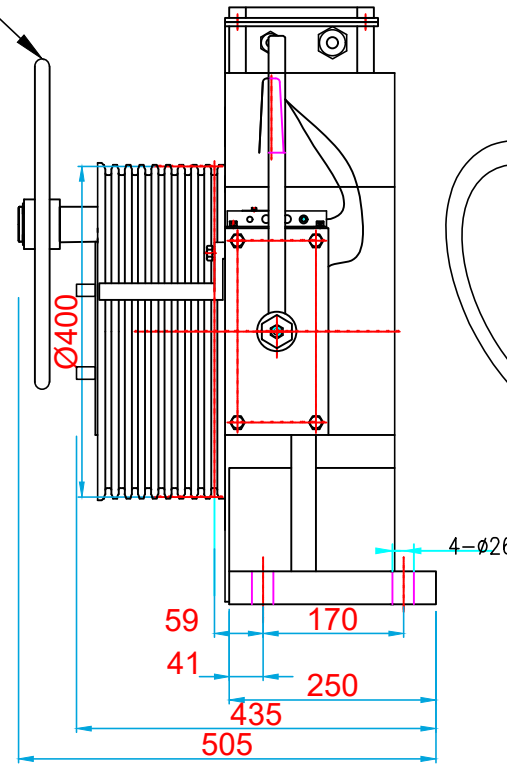

YAN GÖRÜNÜŞ / RIGHT VIEW

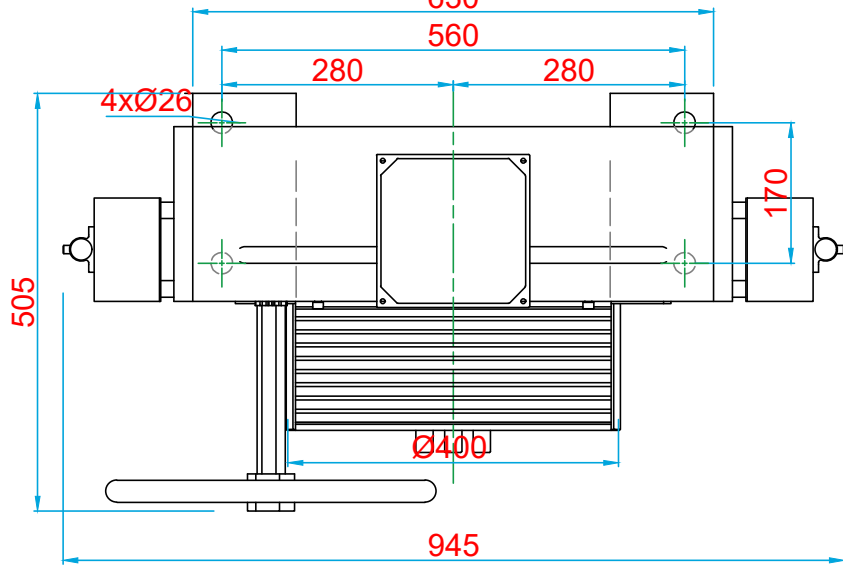
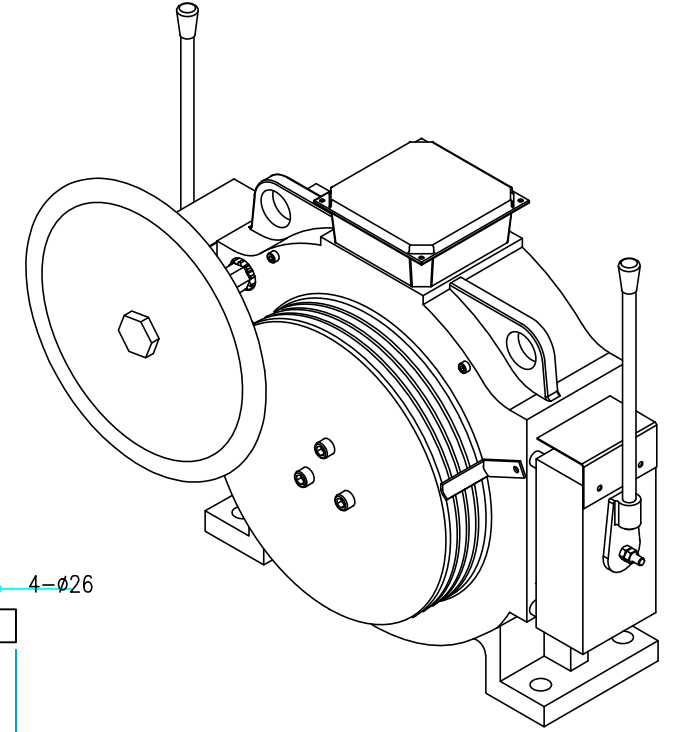

ÜST GÖRÜNÜŞ / TOP VIEW



KOLMAR

ASANSÖR SANAYİ VE TİCARET ANONİM ŞİRKETİ

Tel: +90 (216) 661 55 67
info@kolmar.com.tr
www.kolmar.com.tr

MODEL : WYT-TE 2.0F_2000kg_Ø400_9xØ10_P16

Kapasite/Capacity : 2000 kg

Hız/Speed : 2.0 m/s

Kasnak/Groove : Ø400; 9xØ10